



Multifunction (7 Day Timer) Manual

Installation Instructions
Operating Instructions

Espar Products, Inc.
6099A Vipond Drive
Mississauga, Ontario
Canada L5T 2B2

(905) 670-0960
(800) 387-4800 Canada & U.S.A.
(905) 670-0728 Fax

www.espar.com

Timer only

P/N 22 1000 30 36 00 (Coolant heater 12/24 volt)

P/N 22 1000 30 40 00 (Air heater 12/24 volt)

Timer kit w/mounting bracket

P/N 20 2900 70 02 30 (Coolant heaters)

P/N 20 2900 70 02 35 (Air heaters)

Timers with adaptor but no relay

P/N 20 2900 70 02 01 (Coolant heater 24 volt)

P/N 20 2900 70 02 10 (Air heater 12 volt)

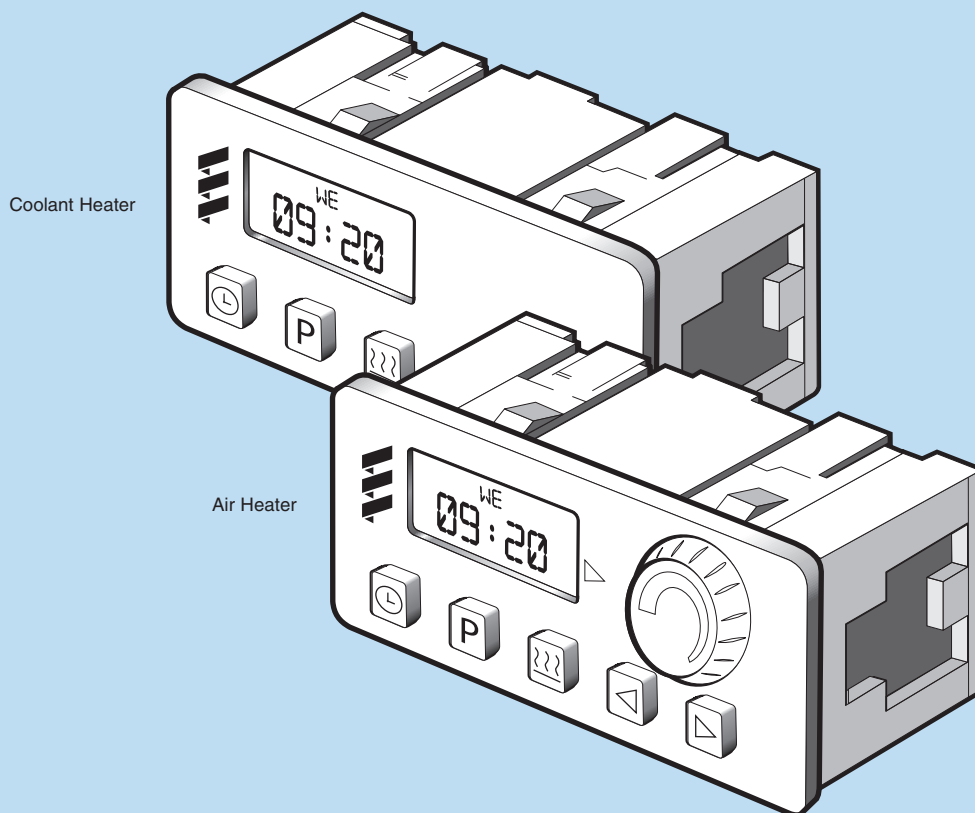

Instructions

7 Day Timer Instructions

The 7 Day Timer has been designed to provide a simple means to control the operation of the heater system and to include diagnostics capability. This timer connects to the diagnostic circuit of the heater. The timer then displays any heater fault codes in three digit number form automatically. The timer allows for pre-selection of turn on time, up to 7 days in advance, as well as an option for run times up to 2 hours before automatically turning off. In addition, there is an on/off switch for manual operation. By default the timer is pre-set by Espar to operate for two hours.

Mounting Bracket and Bezel

P/N 25 1482 70 01 00

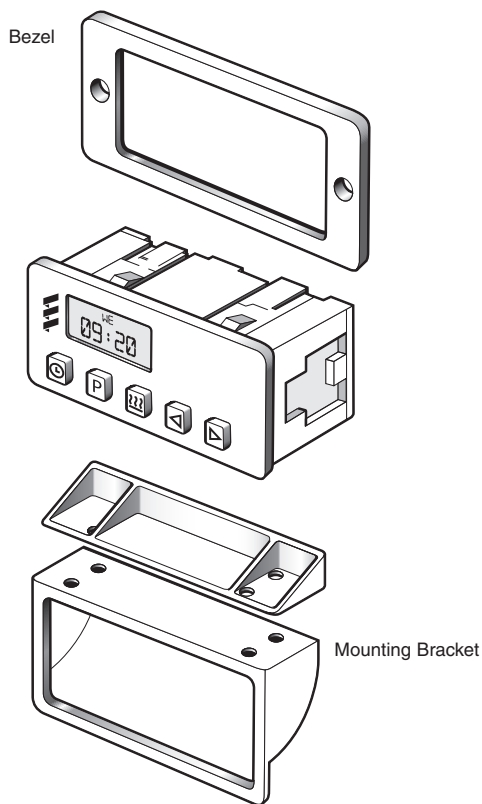



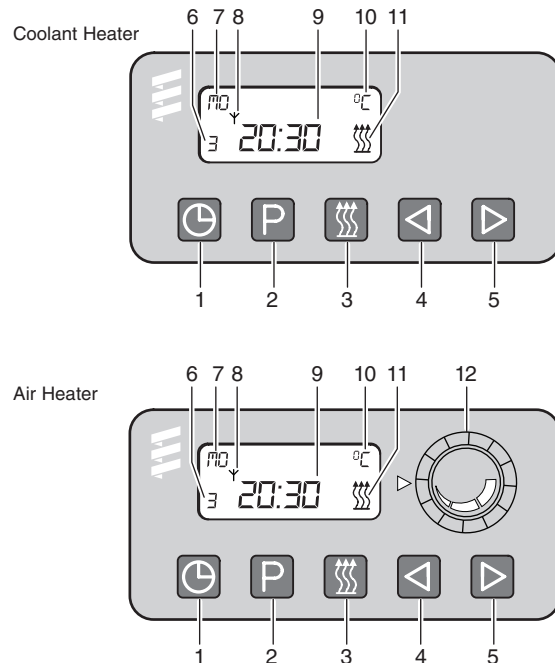

- 1 Mount bezel into dash and insert timer or use Espar's optional mounting bracket and secure to dash.
- 2 Neatly route and secure harness under dashboard.
- 3 Cut harness to length and terminate wires attach using connectors provided. Insert terminals into housing.
- 4 Connect harness to timer.

Operating Instructions



1. Timer Set
2. Pre-heat Time Set
3. Heater "ON"
4. Backward Scan
5. Forward Scan
6. Memory Display
7. Weekday or Preset Day
8. Symbol for Radio Remote Control
9. Current Time or Preset Time
10. Temperature Display
11. "Heat" Symbol
12. Temperature Preselection (Range 10-30°C Air Heater only)

Setting Time and Weekday

Push  button once 12:00 will begin to flash (this will occur upon initial hook up to power).
Using  or  set the present time of day (24 hour clock).
When the time stops flashing the time has been stored.
The weekday will now begin to flash.
Use  or  to set the present weekday.
When the weekday stops flashing the weekday has been stored

When the vehicle ignition is turned "on" the time display will appear, if optional connection on pin 10 is installed.
When the vehicle ignition is turned "off" the timer display will go off after 15 seconds.

Changing the Time or Day

Push and hold  button until the time display begins to flash.
Continue to set the time as listed in setting time and weekday.



Instructions

Using the Timer with the Vehicle Ignition "Off"

Push button.
 will appear on the display as well as the operation count-down timer.
 The running time is factory set to maximum of 120 minutes.
 This running time can be reset once or permanently as desired.

Adjusting Preheat Time Once

Press button.
 The will appear in the display and the preselected run time will appear in the display (maximum time of 120 minutes).
 Use the or to adjust the desired run time.

Adjusting the Heater Preheat Time Permanently

(Maximum Preheat Time of 120 minutes)

Push and hold (about 3 seconds) until the display lights up and flashes. Release button.
 Use or to set the new fixed preheat time.
 When the display goes off the new preheat time is set.

Note: At the end of a preheat cycle the timer will turn the heater off. The heater will complete a cool down cycle and turn itself off

Using the Heater Manually with the Vehicle Accessory "On"

(Optional wire on pin 10 is connected to the ignition lock)

Push button.
 The symbol will appear in the display next to the time of day.
 The time of day will remain displayed during ignition on operation.
 The heater will function continually as long as the vehicle ignition is "On".
 When the vehicle ignition is turned "Off" the heater will continue to operate for an additional 15 minutes.
 The run time can be altered by pressing the or buttons.
 The heater can be turned off by pressing button.

Set Preheat Times into Memory

Press button until the desired memory location is shown in the display (Three memory locations are available).
 Using the or buttons set the desired preheat start time of day.
 When the time stops flashing the time of day is set.
 Using the or buttons set the desired day of the week.
 When the day of the week stops flashing the day is set.

To Use Preset Start Times

Press the button until the desired memory location appears in the display.
 The heater will start at the day and time displayed.
 The display will go off in 15 seconds. The memory location number will stay displayed (1, 2 or 3).
Note: When preset is chosen this symbol will flash red.

To Turn Heater "Off"- All Modes

Press the button once.
 The heat signal to the heater will be turned "Off".
 The heater will do a normal cooldown and turn itself "Off".

Note: When the vehicle lights are turned "On" the timer backlight will come "On" also.

Note: This timer is equipped to display fault code numbers if the heater should shut down due to an operating fault. The fault code will show in the timer display next to the flashing heat wave symbol. This applies to all current model heaters when the blue diagnostic wire is connected.

Note: If the timer is purchased without the harness kit, the following heaters will need a load relay intalled (D8Lc, D7W, D12W, D24W and D30W).
 These heaters carry a load on the switch wire. (i.e. fuel metering pump or solenoid valve).

Note: An outside temperature sensor is available as an option.

Coolant Heater Timer Connections

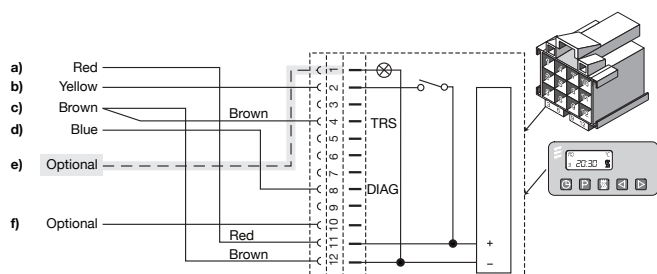

- a) Power from battery "+"
- b) Switch control to heater
- c) Power from battery "-"
- d) Diagnostic from heater
- e) To vehicle dimmer switch for light display
- f) To vehicle ignition accessories for continuous operation of heater and for unlocking heaters ECU

Air Heater Timer Connection

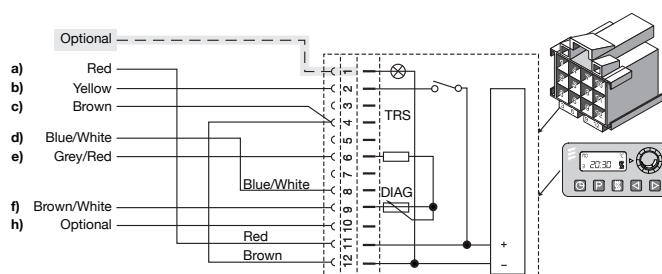

- a) Power from battery "+"
- b) Switch control to heater
- c) Power from battery "-"
- d) Diagnostic from heater
- e) Temperature setting "+"
- f) Temperature setting "-"
- g) To vehicle dimmer switch for light display
- h) To vehicle ignition accessories for continuous operation of heater and for unlocking heaters ECU

Instructions

Wiring Connections at Connector

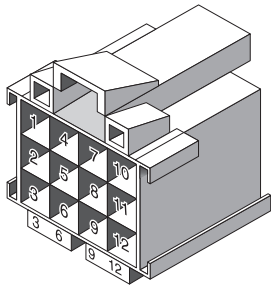

Terminal 1	Power from vehicle dash lights.
Terminal 2	Heater switch wire - Yellow wire.
Terminal 4	Connect to vehicle ground.
Terminal 6	Temperature setting "+" (air only).
Terminal 8	Heater diagnostic lead - blue wire.
Terminal 9	Temperature setting "-" (air only).
Terminal 10	To vehicle "ACC" accessory for continuous overnight use, and for unlocking ECU.
Terminal 11	Positive power from heater - red "+".
Terminal 12	Ground lead from heater - brown "-".
Terminal 3,5,7	Left blank, not required.

Control Unit Locking

The control unit may become locked due to one of the following conditions:

- 1. Overheat** – If the heater overheats three times in succession, fault message F15 is displayed and the control unit is locked.
- 2. Too many failed start attempts** - If the heater performs many start attempts in succession (i.e. Fault 52), fault message F50 is displayed and the control unit is locked.

Unlocking Control Units and Erasing Fault Memory

Please Note!

The electrical connection for the ignition / accessory wire to the timer terminal #10 must be in place.

1. Turn on the vehicle ignition to activate timer display.
2. Press the key. The current fault code (i.e. F15 or F50) is now displayed.
3. Press the key and hold it down and press the key within two seconds. The timer is now in the retrieval mode.
4. Turn off the ignition.

Notes:

Special Notes

Note: Highlight areas requiring special attention or clarification.

Caution. Indicates that personal injury or damage to equipment may occur unless specific guidelines are followed.



Warning: Indicates that serious or fatal injury may result if specific guidelines are not followed.

5. Press the key and hold it down and press the key within two seconds and hold it down.
6. While holding down keys, turn ignition on and wait until the following display appears:



7. Press the key to turn the heater off.
8. Press the key to turn the heater on.
9. Repeat step three. The following display appears:

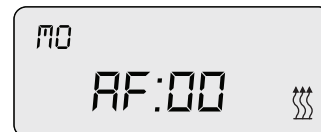

10. The control unit lock is cancelled after three seconds and the heater starts.

Retrieving the Stored Fault Codes

1. Press the key. The heater is switched on.
2. Press the key and hold it down and press the key within two seconds. The current fault code is now displayed (Example: AF:64).
3. The stored fault codes (maximum of 5) can now be retrieved using the arrow keys and (Example: F1:64).

Please NOTE!

Consult the Troubleshooting and Repair manuals for code definition and corrective action. If the heater is not being operated using the 7-day timer, fault code retrieval can be obtained using the "Fault Code Retrieval Device", part number 20 2900 70 50 20.

Espar Products, Inc.

6099A Vipond Drive
Mississauga, Ontario
Canada L5T 2B2

(905) 670-0960 Canada

(905) 670-0728 Fax

(800) 387-4800 Canada & U.S.A.

www.espar.com